

# Instruction Manual

## Refrigerator

No frost

Model

HR4N7522DS  
HR4N7522DSXMY  
HR4N7522DSXSG



Thank you very much for purchasing the Hitachi refrigerator.  
Before installation and usage, please read the user's guide carefully  
for the correct usage.

Maintenance work must only be carried out at works  
by well-trained maintenance work.

# HITACHI

## Content

### Preparation for Use

<b>Warning and Caution for Safety</b> .....	2
<b>Preparations before Use</b> .....	4
■ Installation .....	4
■ Beginning .....	4
■ Food Storage .....	4
<b>Location of Food Storage</b> .....	4

### Installation

Space Requirement .....	5
Levelling the unit .....	5
Level doors .....	5
Rubber blocks .....	6
Positioning.....	7
Electrical connection.....	7

### Operation

<b>How to use the Control panel</b> .....	8
■ Name and Function of Display .....	8
■ Operating Condition .....	8
■ Temperature and function setting .....	9
■ Door Open Alarm .....	10
<b>Multi-Temperature Zone</b> .....	11

### Daily Use

Frist use .....	12
Daily use.....	12
Temperature setting recommendation.....	13
Impact on Food Storage .....	13
Accessories.....	15
Helpful hints and tips.....	15
Hints for storage of frozen food .....	15
Hints for fresh food refrigeration .....	15
Cleaning .....	16
Defrost Description (No Frost) .....	16

### Maintenance

<b>Troubleshooting</b> .....	17
------------------------------	----

For household use only

R600a  
Refrigerant

# Warning and Caution for Safety



To avoid harm to the user, other persons or damage to property, please read and follow the warnings and cautions below and those given throughout this manual.

The following warnings and cautions are categorized by the level of possible harm or damage that may occur from ignoring directions.

This symbols are shown as below clearly showing the significance of directions.

	<b>WARNING</b>	This pictograph indicates "There is a high possibility of serious injury or death, if ignored".
	<b>CAUTION</b>	This pictograph indicates "There is a high possibility of injury or damage to property, if ignored".

- This refrigerator use flammable refrigerants. The symbol column below states the precautions on flammable refrigerants.

The symbols below are examples.	
	This symbols is an alert mark.
	This symbols indicates "prohibited".
	This symbols indicates "necessary".



**R600a**









**This symbol denotes the precautions on flammable refrigerants.**

## WARNING







### When you install ... To avoid fire, electric shock, and injury.

-  Do not install the refrigerator in a place where it may come in contact with water.
-  Do not install the refrigerator in a place exposed to rain.
  - This may impair electricity insulation and cause electric shock or fire.
-  Ground this refrigerator to prevent electric shock and noise interference. Always ground this refrigerator and install earth leakage circuit breaker when using it in place with high humidity or moisture. (Please consult with a retailer or Hitachi Service Center.)

### Power Cord and Power Plug ... To avoid fire, electric shock.

-  Do not connect the wall outlet whose power capacity is less than the refrigerator's. Also, do not use power sources that are not a rated voltage.
  - If a power source is shared with other appliances using double or multipoint adapters.
  - Do not locate multiple portable socket-outlets or portable power supplies at the rear of the appliance.
-  Do not use a damaged or loose power plug or power outlet. This may cause fire or electric shock.
-  Do not cut, bend, fold the power cord to avoid fire and electric shock.
  - When positioning the appliance, ensure the supply cord is not trapped or damaged.
-  Be sure to unplug the power plug before maintaining the refrigerator.
  - Be sure to hold the power plug to unplug.
-  Connect the power plug firmly to a power outlet with the cord running down.
  - Connection of the power plug with the cord running up could apply stress on the cord and cause electrical short or overheat, which could result in electrical shock or fire.
  - Incomplete connection of the power plug could result in electrical shock or fire due to heat.
-  If the supply cord is damaged, it must be replaced by the manufacturer, its service agent or similarly qualified persons in order to avoid a hazard.
-  Clean the dust on the power plug frequently with dry cloth.
  - Unplug the power plug and wipe it with dry cloth.
  - An insulation failure due to moisture or when dust collects on the power plug may cause fire.
-  Do not insert or remove the power plug with wet hands.

### During daily use ... To avoid fire, electric shock.

-  Do not splash water on or inside the refrigerator.
  - This may impair electricity insulation causing electric shock or fire.
  - This may also cause gas leakage because of pipe rust.
-  This appliance is not intended for use by persons (including children) with reduced physical, sensory or mental capabilities, or lack of experience and knowledge, unless they have been given supervision or instruction concerning use of the appliance by a person responsible for their safety.
-  Do not hang on the doors or step up on the various compartments.
  - Injury may be caused by the refrigerator tipping over or hands getting caught in door.
-  Do not enter in the refrigerator.
-  Do not disassemble, repair, or modify the refrigerator by yourself.
  - Please consult with a retailer or Hitachi Service Center if any repair is required.
-  Ether, liquid propane gas, solvent, aerosol cans, etc. which is volatile cannot be stored in this refrigerator.
  - Do not store anything that are generate heat or fire spark inside the refrigerator.
-  Do not put water containers or foreign articles on the top of the refrigerator.
  - Opening and closing doors etc. may cause the articles on the top of the refrigerator to fall down, resulting in injury.



## ! WARNING



- Do not damage the refrigerant circuit.
  - If there the damage of refrigerant pipe happened, stay away from the refrigerator and avoid using fire and electrical appliances.
  - Open windows to ventilate and contact retailers or Hitachi Service Center.

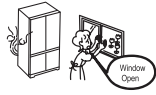

- Medicines, chemicals, research and experimental substances should not be stored in the refrigerator.
  - Substances that require precise conditions for storage cannot be stored in a domestic refrigerator.



- Do not use electrical appliances inside the food storage compartments of the appliance, unless they are of the type recommended by the manufacturer.



- Do not use mechanical devices or other means to accelerate the defrosting process, other than those recommended by the manufacturer.



- In an event of a flammable gas leak, do not touch the refrigerator and open windows for ventilation.
  - Sparks from points of electrical contacts such as door switches may ignite explosions causing fire or a burn.



- Children should be supervised to ensure that they do not play with the appliance.
  - Children getting inside may not be able to get out.
- Cleaning and user maintenance shall not be made by children without supervisor.



- Do not use the refrigerator in the atmosphere of flammable gas.



- Do not make an impact on the glass-made doors or shelves.
  - They are made of tempered glass, however, an excess impact may be result in breakage and is dangerous.



- If you find something wrong with the refrigerator, immediately unplug and consult with the retailers or Hitachi Service Center.



- Follow the instructions of your region when discarding.



- When discarding the refrigerator, remove the door gaskets.
  - To avoid a risk of an infant or child to be entrapped inside.



- This refrigerator uses R-600a for the refrigerant and cyclopentane for the blowing agent of the urethane heat insulation.



### When discarding the refrigerator.

## ! CAUTION

### During daily use ...To avoid illness and injury.



- Do not put bottles, etc. forcibly in the door pockets.
  - This may cause bottles to drop down or door pockets to come off.



- Do not store food which smells or food whose color is changed abnormal.
  - Such an action may cause diseases.



- Food and containers inside the freezer compartment should not be touched with wet hands.
  - This may cause frost injury. (Especially in case of metal items.)



- Do not hold the top, bottom and side of the doors when closing them.
  - This may result in your fingers being caught by the door edge.



- If someone else is using the refrigerator, do not open the door.
  - Fingers may get caught in the spaces between the doors and may cause injury.



- Do not have food items protruding over the front edge of each shelf.
  - Doors may not be closed properly or the door pockets may drop down. Injury may be caused from items like bottles getting knocked over your feet.

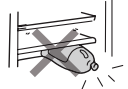

- Do not store glass bottles in the freezer compartment.
  - Bottles may break by the contents freezing and cause injury.



- Do not put your hands into the base surface of the refrigerator cabinet.
  - When cleaning, putting your hands near the base surface of the refrigerator may result in injury by thin metal sheets.



- Be sure to hold the handle firmly to open or close the door.



- Do not have your feet too close when opening the door of the refrigerator.
  - When opening the door, your feet may be hit, resulting in injury.



### When moving or carrying ... To avoid damaging, wetting, soiling the floor, or to avoid injury.



- Use the carrying handle when carrying the refrigerator.
  - Hold the carrying handles only. If hold door handles, hands may slip and may cause injury.
  - Carry the refrigerator by at least 4 persons for safety reasons.
  - Carry it with the doors facing upward.
- Before carrying the refrigerator:
  - Take out all food items and ice cubes.
  - Lay a protective sheet or cloth to protect the floor from damage and catch remaining water spilled from the refrigerator.
  - With a large piece of old cloth underneath, tilt the refrigerator backward to drain water.
  - Finally carry the refrigerator with the doors facing upward.
    - Secure the doors well with adhesive tapes so they do not open.
    - If transporting in a vehicle, do not load the refrigerator on its side. This could damage the compressor.



- Do not use door handles when carrying the refrigerator.



- Never use the carrying handles to hang up with a chain hoist or similar machines.

- On a floor that is easily scratched, do not move the refrigerator with the wheels of refrigerator.
  - The wheels may scratch the floor.
  - For a floor that may be easily scratched, lay a protective mat, etc..



### When replacing lamps (LED) is required.



- When lamps (LED) need to be replaced, please contact Hitachi Service Center.

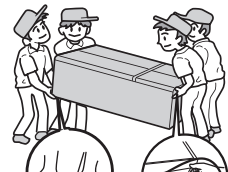
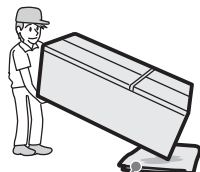

Such as old cloth



# Preparations before Use

## 1 Installation

- 1) Install on a rigid and level floor.
- 2) Please use this refrigerator between the room temperature of 10°C to 43°C. Sufficient performance may not be obtained, if room temperature is too low or too high.
- 3) Do not install where the refrigerator is exposed to direct sunlight or other heat source.
- 4) Install in an atmosphere which is dry or has air ventilation.
- 5) The refrigerator requires enough air ventilation space around the cabinet to have efficient cooling performance. Space of at least 50 mm over the top, 50 mm at rear and 50 mm at both sides for proper air circulation is needed.
- 6) Ground the refrigerator to prevent electric shock and noise interference. Always ground this refrigerator when using it in place with high humidity or moisture. (Please consult with retailers or Hitachi Service Center.)
- 7) Adjusting the adjustable legs to keep the left/right refrigerator door level,
  - Without adjusting the legs, door height may not be level, or there may be abnormal vibration or noises depending on floor conditions. Follow the instructions below.
  - Turn the adjustable legs until they touch the floor firmly.

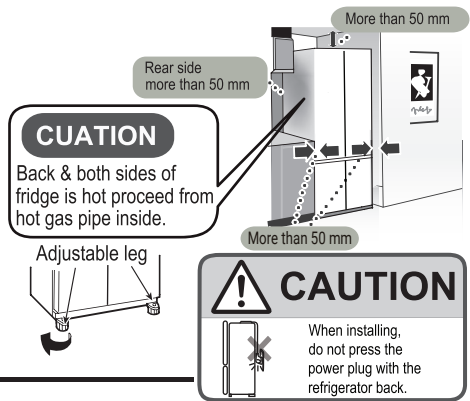

## 2 Beginning

- 1) After transporting : If Refrigerator has been kept horizontal position for more than 10 minutes for transportation or any other reasons, it should stand upright for more than 1 hour before plugging it in.
- 2) Cleaning inside the refrigerator. Wipe the surface gently with soft cloth.
- 3) Connect the refrigerator to an exclusive wall power outlet. The refrigerator can be connected to an outlet soon after it is installed. Surely use with the rated voltage and exclusive power outlet.
- 4) The compressor will start running in approximately 30 seconds, if inside is not cold.
- 5) Allow enough duration for sufficient cooling before storing food. It may take about 4 hours to fully cool down and could even take about 24 hours when the ambient temperature is high.
- 6) Opening the door for long periods can cause a significant increase of the temperature in the compartments of the appliance.

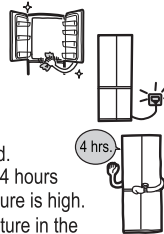

## 3 Food storage

- 1) Keep enough space between food. Several food placed too close together may obstruct the flow of cold air.
- 2) Make food cool enough before putting it in the refrigerator. Putting warm food in the refrigerator raises the inside temperature and wastes electricity.
- 3) Do not block the cold air vent. This will adversely affect the cold air flow and may not keep the temperature inside even. Moreover, it could result in food near the vent freezing.
- 4) Using plastic wrap or sealed containers prevent the food from drying or transition of smells.
- 5) Store raw meat and fish in suitable containers in the refrigerator, so that it is not in contact with or drip onto other food.

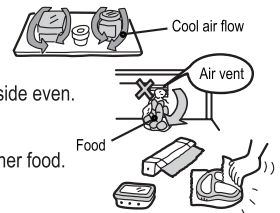

# Location of Food Storage

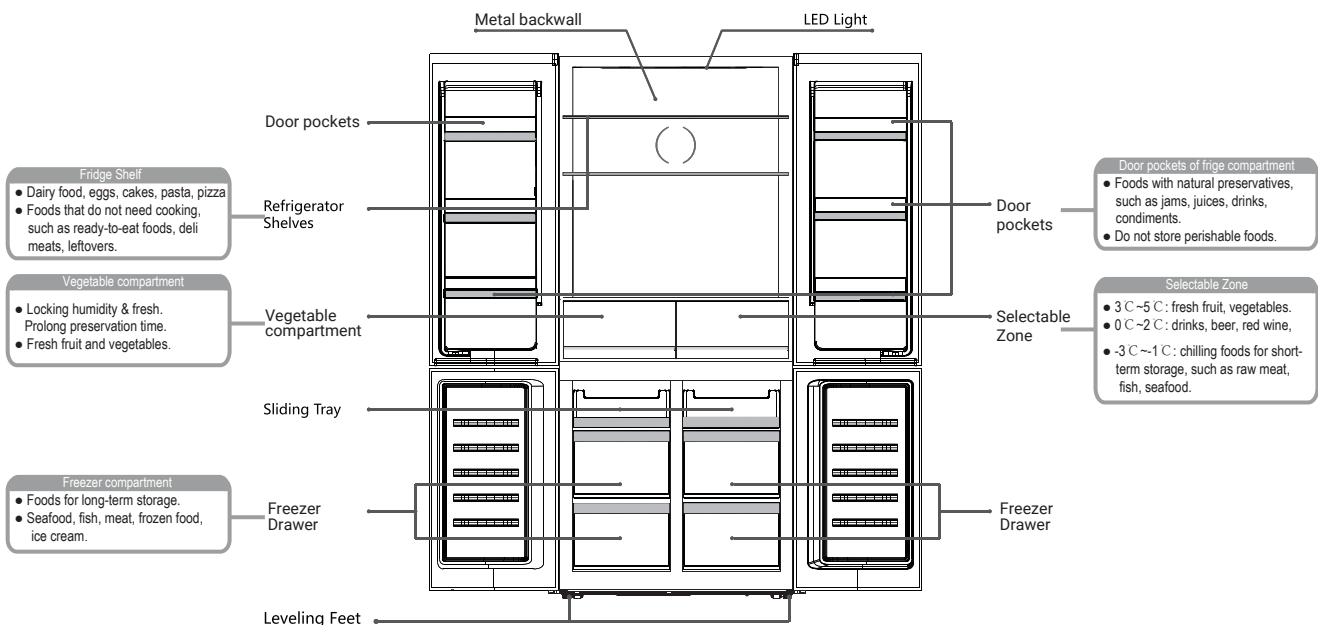

## NOTICE

- This illustration is only for hinting, the detail please check your appliance.

# Installation

## Space Requirement

- Keep enough space of door open.

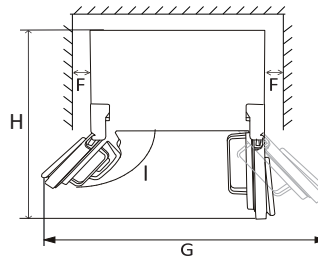
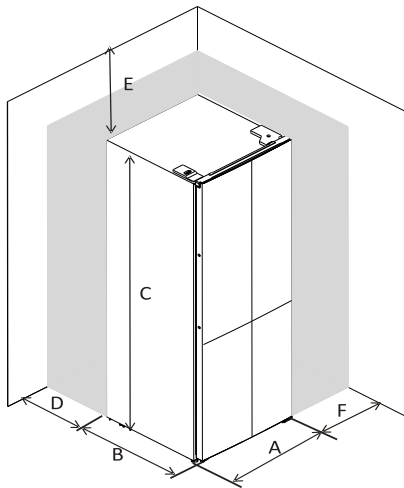

A	795
B	735
C	1800
D	min=50
E	min=50
F	min=50
G	1580
H	1530
I	135°

## Levelling the unit

To do this adjust the two levelling feet at front of the unit.

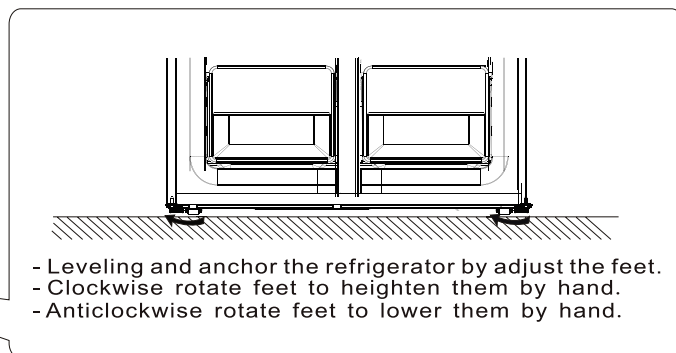
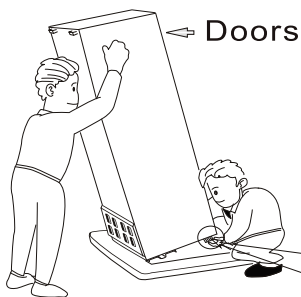

## Level doors

After transportation or door balconies are loaded by food or beverage, upper two doors may not be aligned. There are 3 C type washers which are used to adjust doors. Please follow below process to level doors.



1. Before check alignment of doors, please make sure appliance stand levelly .
2. If top of upper two doors looks not in a line, please slightly lift lower door and insert a pieces of C type washer by a clip between bottom of door and middle hinge.

# Installation

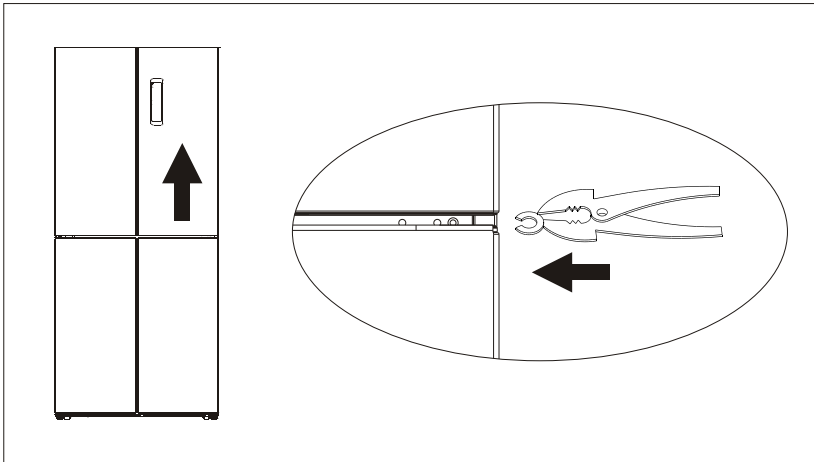

## WARNING

Please be careful to avoid fingers are clipped by door. Please use tool.

## WARNING

Please keep C type washers far away children to avoid them are swallowed by children. They are small parts.

## Rubber blocks

There is one rubber block on each door. They function as spring to relieve impact when door closes .

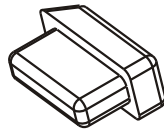

Please not pull the rubber blocks. If they absent from the doors, please take one from accessory bag and insert it to the hole of door.

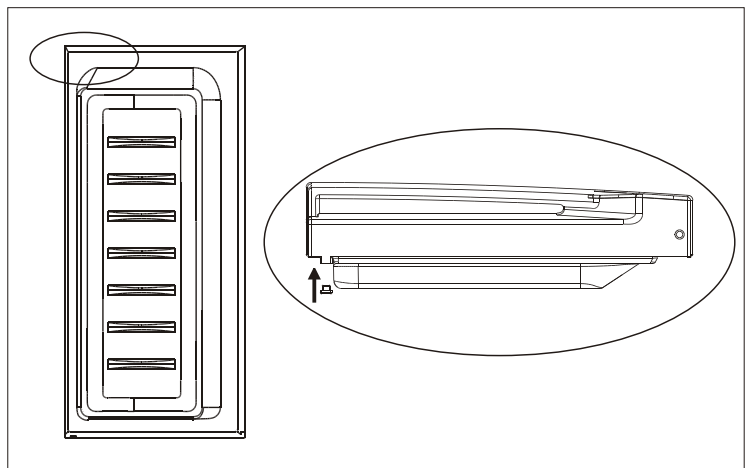

# Installation

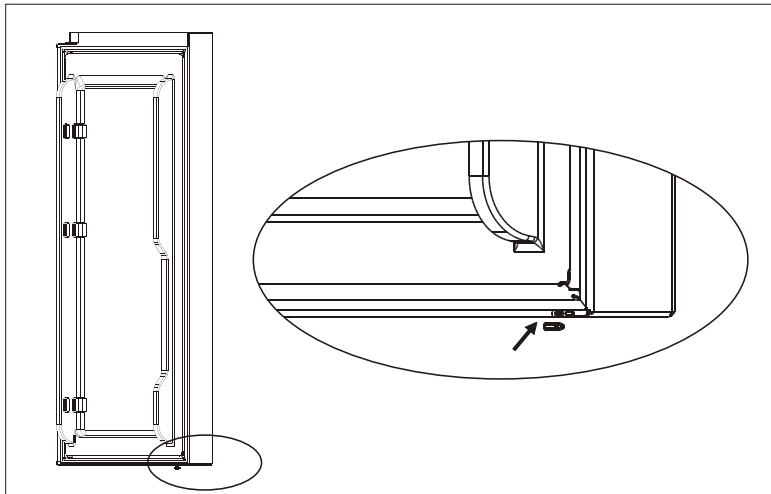

## WARNING

Please keep rubber blocks far away children to avoid them are swallowed by children. They are small parts.

## Positioning

Install this appliance at a location where the ambient temperature corresponds to the climate class indicated on the rating plate of the appliance:

for refrigerating appliances with climate class:

- extended temperate: this refrigerating appliance is intended to be used at ambient temperatures ranging from 10 °C to 32 °C; (SN)
- temperate: this refrigerating appliance is intended to be used at ambient temperatures ranging from 16 °C to 32 °C;(N)
- subtropical: this refrigerating appliance is intended to be used at ambient temperatures ranging from 16 °C to 38 °C;(ST)
- tropical: this refrigerating appliance is intended to be used at ambient temperatures ranging from 16 °C to 43 °C;(T)

## Location

The appliance should be installed well away from sources of heat such as radiators, boilers, direct sunlight etc. Ensure that air can circulate freely around the back of the cabinet. To ensure best performance, if the appliance is positioned below an overhanging wall unit, the minimum distance between the top of the cabinet and the wall unit must be at least 50 mm. Ideally, however, the appliance should not be positioned below overhanging wall units. Accurate leveling is ensured by one or more adjustable feet at the base of the cabinet.

This refrigerating appliance is not intended to be used as a built-in appliance;

## WARNING

It must be possible to disconnect the appliance from the mains power supply; the plug must therefore be easily accessible after installation

## Electrical connection

Before plugging in, ensure that the voltage and frequency shown on the rating plate correspond to your domestic power supply. The appliance must be earthed. The power supply cable plug is provided with a contact for this purpose. If the domestic power supply socket is not earthed, connect the appliance to a separate earth in compliance with current regulations, consulting a qualified electrician.

The manufacturer declines all responsibility if the above safety precautions are not observed  
This appliance complies with the E.E.C. Directives



# How to use the Control Panel

## 1

### Name and Function of Display

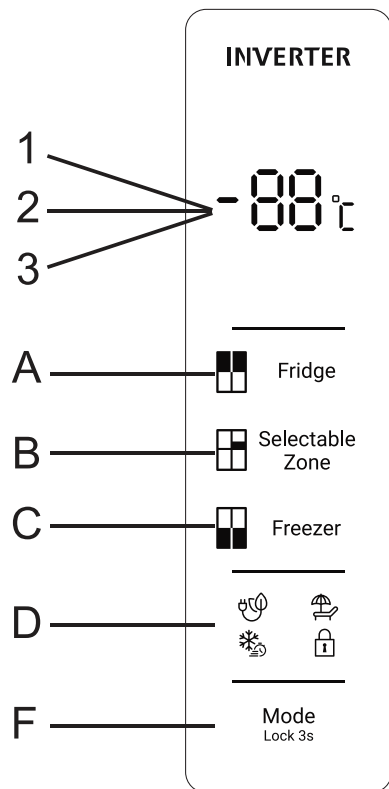

#### 1.1 KEY OPERATION

- A. Fridge Temp. Setting
- B. Selectable Zone Temp. Setting
- C. Freezer Temp. Setting
- D. Mode Setting (Energy Saving Mode – Holiday Mode – Quick Freezing)
- F. Locking/Unlocking Setting

#### 1.2 LED DISPLAY

- 1. Temperature of Fridge Compartment
- 2. Temperature of Freezer Compartment
- 3. Temperature of Selectable Zone

## 2

### Operating Condition

- a. The control panel is 100% lit up for 3 seconds, which operates exactly as per the setting (mode and temperature) before the poweroff. The system will be automatically locked 25 seconds after the last key operation. After locking, the light of the panel would be out 120 seconds after the last key operation.
- b. The Fridge/Freezer/Selectable Zone temperature will be showed Separately by setting each zone temperature.

#### 2.1 DISPLAY

2.1.1 The panel will be lit up for 2 minutes once the door of fridge compartment or freezer compartment is opened. (one door signal is sensed at a time)

2.1.2 The panel will be lit up by any key operation whereas the light would be out 2 minutes after the last operation.

#### 2.1.3 Display during normal operation

Temperature Display of the Fridge Compartment: Indicating the temperature of the current setting.

Temperature Display of the Freezer Compartment: Indicating the temperature of the current setting.

Temperature Display of the Selectable Zone Compartment: Indicating the temperature of the current setting.

# How to use the Control Panel

## 3

### Temperature and function setting

#### 3.1 Temperature Control of the Fridge Compartment

Temperature Control of the Fridge Compartment:

This key is workable both in User Defined Mode as well as Quick Freezing. After entering the temperature control of the fridge compartment, this key flashes. By touching the key consecutively, the temperature would change in a circle of "2°C, 3°C, 4°C, 5°C, 6°C, 7°C 8°C", after which 5-second flashing means the selection of temperature is settled.

#### 3.2 Temperature Control of the Freezer Compartment

Temperature Control of the Freezer Compartment: This key is workable both in User Defined Mode as well as Holiday Mode. After entering the temperature control of the freezer compartment, the key flashes. By touching the key consecutively, the temperature would change in a circle of "-14°C, -15°C, -16°C, -17°C, -18°C, -19°C, -20°C, -21°C, -22°C", after which a 5-second flashing means the selection of temperature is settled.

#### 3.3 Temperature Control of the Selectable Zone Compartment

Temperature Control of the Selectable Zone Compartment:

This key is workable both in User Defined Mode as well as other models. After entering the temperature control of the Selectable Zone compartment, this key flashes. By touching the key consecutively, the temperature would change in a circle of "5°C, 4°C, 3°C, 2°C, 1°C, 0°C, -1°C, -2°C, -3°C", after which 5-second flashing means the selection of temperature is settled.

#### 3.4 Mode/ Locking / Unlocking

a. By touching this key consecutively, the operation mode of the refrigerator will change in a circle of "Energy Saving Mode – Holiday Mode – Quick Freezing- User Defined Mode. A 5-second flashing means the selection of temperature is settled.

b. Long Touch to Enter / Exit Locking Mode

- Unlocking: Touch for 3 seconds in the mode of locking, all the keys would be unlocked after the a beep.
- Locking: Touch for 3 seconds in the mode of unlocking, all the keys would be locked after the a beep.

#### 3.5 Touch Button

Short beep after per touch button

All buttons will only valid under unlock mode.

#### 3.6 Lock Fnciton

No operation in 25 sec will lock the display automatically.

#### 3.7 Energy Saving Mode

Touch mode to choose Energy Saving Mode, ECO icon keeps bright after 5 sec flashing.

Temperature fix 6°C in Fridge compartment and -16°C in Freezer compartment under Energy Saving Mode "Freezer"&"Fridge" button in vain while ECO icon will flash three times in alarm. The temperature of Selectable Zone compartment can be adjusted freely by operating the Selectable Zone temp. setting.

Energy Saving Mode:

Choose mode, exit Energy Saving Mode after 5 sec, entering the selected mode.

# How to use the Control Panel

---

## 3.8 Holiday Mode

Touch mode to choose Holiday Mode, the icon keeps bright after 5 sec flashing, entering holiday mode.

Temperature fix 17°C in fridge compartment, "Fridge" button in vain, while Holiday icon will flash three times in alarm.

Temperature of freezer compartment and Selectable Zone compartment can be adjusted freely.

Exit Holiday Mode:

Choose mode, exit Holiday Mode after 5 sec, entering the selected mode.

## 3.9 Quick Freezing

Choose mode, the icon keeps bright after 5 sec flashing, entering Quick Freezing.

Quick Freezing:

Temperature fix -25°C in freezing compartment, "Freezer" button in vain, while freezing icon will flash three times in alarm.

Temperature of fridge compartment and Selectable Zone compartment can be adjusted freely.

Exit Quick Freezing :

meeting below conditions.

- manually exit Quick Freezing.
- freezing period more than 50 hours

Mode remains the same before entering Quick Freezing.

---

# 4

## Door Open Alarm

If fridge (upper) door keeps open for 60 seconds, periodical alarm will be arisen until the door is closed.

# Multi-Temperature Zone

---

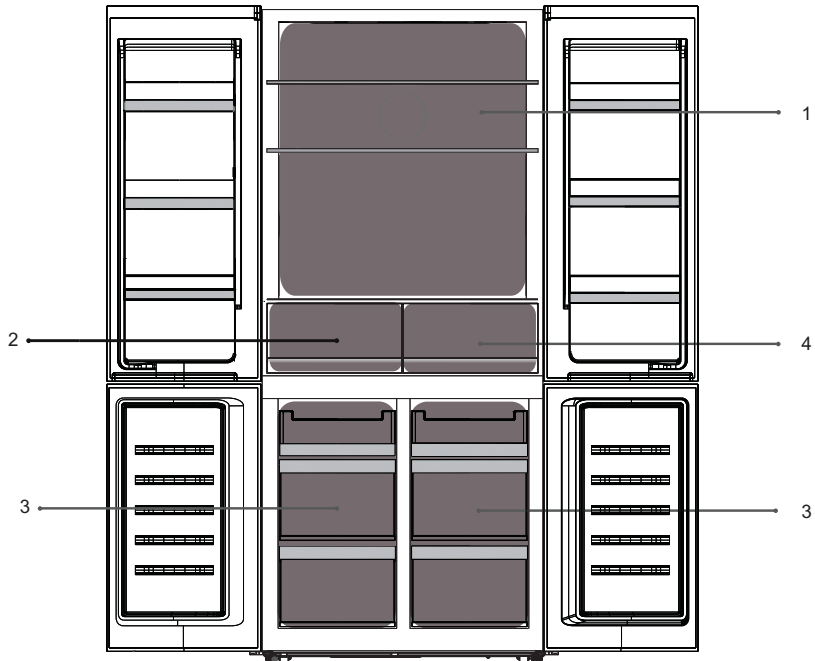

1.Fridge temp. 2°C~8°C  
Controlled by operating display panel

2.Fresh temp. 2°C~8°C

3.Freezer temp. -22°C~-14°C  
Controlled by operating display panel

4.Selectable Zone temp. -3°C~5°C  
Controlled by operating display panel

# Daily Use

---

## ■ First use

### Cleaning the interior

Before using the appliance for the first time, wash the interior and all internal accessories with lukewarm water and some neutral soap so as to remove the typical smell of a brand new product, then dry thoroughly.

**Important!** Do not use detergents or abrasive powders, as these will damage the finish.

## ■ Daily use

Position different food in different compartments according to be below table below table

Refrigerator compartments	Type of food
Door pockets of fridge compartment	<ul style="list-style-type: none"><li>• Foods with natural preservatives, such as jams, juices, drinks, condiments.</li><li>• Do not store perishable foods.</li></ul>
Fridge shelf	<ul style="list-style-type: none"><li>• Dairy food, eggs, cakes, pasta, pizza</li><li>• Foods that do not need cooking, such as ready-to-eat foods, deli meats, leftovers.</li></ul>
Vegetable compartment	<ul style="list-style-type: none"><li>• Locking humidity &amp; fresh. Prolong preservation time.</li><li>• Fresh fruit and vegetables.</li></ul>
Selectable Zone	<ul style="list-style-type: none"><li>• 3°C~5°C: fresh fruit, vegetables.</li><li>• 0°C~2°C: drinks, beer, red wine.</li><li>• -3°C~-1°C: chilling foods for short-term storage, such as raw meat, fish, seafood.</li></ul>
Freezer compartment	<ul style="list-style-type: none"><li>• Foods for long-term storage.</li><li>• Seafood, fish, meat, frozen food, ice cream.</li></ul>



# Daily Use

## ■ Temperature setting recommendation

Temperature Setting Recommendation	
Environment Temperature	Temperature Setting
Summer (Above 38°C)	Fridge set on 2°C
	Freezer set on -20°C
Normal	Fridge set on 4°C
	Freezer set on -18°C
Winter (Below 16°C)	Fridge set on 5°C
	Freezer set on -18°C

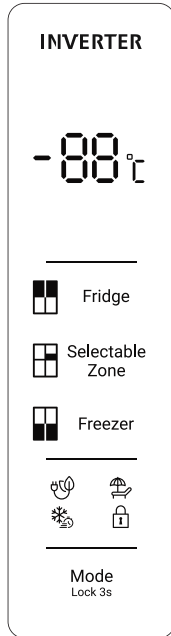

- Information above give users recommendation of temperature setting.
- Temperature of Selectable Zone setting depends on food leading.

## ■ Impact on Food Storage

- Under Recommended setting, the best storage time of fridge is no more than 3 days.
- Under Recommended setting, the best storage time of freezer is no more than 1 month.
- The best storage time may reduce under other settings.

# Daily Use

---

## ■ Freezing fresh food

- The freezer compartment is suitable for freezing fresh food and storing frozen and deep-frozen food for a long time.
- Place the fresh food to be frozen in the freezer compartment.
- The freezing process lasts 24 hours: during this period do not add other food to be frozen.

## ■ Storing frozen food

When first starting-up or after a period out of use, before putting the product in the compartment let the appliance run at least 2 hours on the higher settings.

**Important!** In the event of accidental defrosting, for example the power has been off for longer than the value shown in the technical characteristics chart under “rising time”, the defrosted food must be consumed quickly or cooked immediately and then re-frozen (after cooked).

## ■ Thawing

Deep-frozen or frozen food, prior to be used, can be thawed in the fridge compartment or at room temperature, depending on the time available for this operation.

Small pieces may even be cooked still frozen, directly from the freezer. In this case, cooking will take longer.

## ■ Ice-cube

This appliance may be equipped with one or more ice-cube to produce ice.

# Daily Use

---

## ■ Accessories

### Movable shelves

The walls of the refrigerator are equipped with a series of runners so that the shelves can be positioned as desired

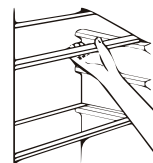

### Door pockets

To permit storage of food packages of various sizes.

Door pockets can be placed at different heights. To make these adjustments proceed as follows: gradually pull Door pockets in the direction of the arrows until it comes free, then reposition as required

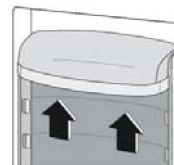

## ■ Helpful hints and tips

To help you make the most of the freezing process, here are some important hints

- the freezing process takes 24 hours. No further food to be frozen should be added during this period, only freeze top quality, fresh and thoroughly cleaned, foodstuffs;
- prepare food in small portions to enable it to be rapidly and completely frozen and to make it possible subsequently to thaw only the quantity required;
- wrap up the food in aluminium foil or polythene and make sure that the packages are airtight,
- do not allow fresh, unfrozen food to touch food which is already frozen, thus avoiding a rise in temperature of the latter;
- lean foods store better and longer than fatty ones; salt reduces the storage life of food;
- water ices, if consumed immediately after removal from the freezer compartment, can possibly cause the skin to be freeze burnt;
- it is advisable to show the freezing in date on each individual pack to enable you removal from the freezer compartment, can possibly cause the skin to be freeze burnt;
- it is advisable to show the freezing in date on each individual pack to enable you to keep tap of the storage time

## ■ Hints for storage of frozen food

To obtain the best performance from this appliance, you should:

- make sure that the commercially frozen foodstuffs were adequately stored by the retailer,
- be sure that frozen foodstuffs are transferred from the food store to the freezer in the shortest possible time;
- not open the door frequently or leave it open longer than absolutely necessary.
- once defrosted, food deteriorates rapidly and cannot be re-frozen;
- do not exceed the storage period indicated by the food manufacture.

## ■ Hints for fresh food refrigeration

To obtain the best performance

- Do not store warm food or evaporating liquids in the refrigerator
- Do cover or wrap the food, particularly if it has a strong flavour
- Make (all types): wrap in polythene bags and place on the glass shelves above the vegetable drawer.
- For safety, store in this way only one or two days at the most.
- Cooked foods, cold dishes, etc...: these should be covered and may be placed on any shelf
- Fruit and vegetables: these should be thoroughly cleaned and placed in the special drawer(s) provided
- butter and cheese: these should be placed in special airtight containers or wrapped in aluminum foil or polythene bags to exclude as much air as possible.
- Milk bottle: these should have a cap and should be stored in the balconies on the door.
- Bananas, potatoes, onions and garlic, if not packed, must not be kept in the fridge

# Daily Use

---

## ■ Cleaning

For hygienic reasons the appliance interior, including interior accessories, should be cleaned regularly.

### CAUTION

The appliance may not be connected to the mains during cleaning. Danger of electrical shock! Before cleaning switch the appliance off and remove the plug from the mains, or switch off or turn out the circuit breaker or fuse. Never clean the appliance with a steam cleaner. Moisture could accumulate in electrical components, danger of electrical shock! Hot vapors can lead to the damage of plastic parts. The appliance must be dry before it is placed back into service.

**Important!** Ethereal oils and organic solvents can attack plastic parts, e.g. lemon juice or the juice from orange peel, butyric acid, cleanser that contain acetic acid.

- Do not allow such substances to come into contact the appliance parts.
- Do not use any abrasive cleaners
- Remove the food from the freezer. Store them in a cool place, well covered.
- Switch the appliance off and remove the plug from the mains, or switch off or turn out the circuit breaker of fuse.
- Clean the appliance and the interior accessories with a cloth and lukewarm water. After cleaning wipe with fresh water and rub dry.
- After everything is dry place appliance back into service.

## ■ Defrost Description (No Frost)

It is a total no frost refrigerator-freezer which will be defrosted automatically.

# Maintenance

## ▪ Troubleshooting

### CAUTION

Before troubleshooting, disconnect the power supply. Only a qualified electrician of competent person must do the troubleshooting that is not in this manual.

**Important!** There are some sounds during normal use (compressor, refrigerant circulation).





Problem	Things to check	Instruction
Appliance dose not work	Mains plug is not plugged in or is loose	Insert mains plug.
	Fuse has blown or is defective	Check fuse, replace if necessary.
	Socket is defective	Mains malfunctions are to be corrected by an electrician.
Appliance freezes or cools too much	Temperature is set too cold or the appliance runs at <b>SUPER</b> modes.	Turn the temperature regulator to a warmer setting temporarily.
The food is not frozen enough.	Temperature is not properly adjusted.	Please look in the initial Temperature Setting section.
	Door was open for an extended period.	Open the door only as long as necessary.
	A large quantity of warm food was placed in the appliance within the last 24 hours.	Turn the temperature regulation to a colder setting temporarily.
	The appliance is near a heat source.	Please look in the installation location section.
Heavy build up of frost on the door seal.	Door seal is not air tight.	Carefully warm the leaking sections of the door seal with a hair dryer (on a cool setting). At the same time shape the warmed door seal by hand such that it sits correctly.
Unusual noises	Appliance is not level.	Re-adjust the feet.
	The appliance is touching the wall or other objects.	Move the appliance slightly.
	A component, e.g. a pipe, on the rear of the appliance is touching another part of the appliance or the wall.	If necessary, carefully bend the component out of the way.
Water on the floor	Water drain hole is blocked.	See the Cleaning and Care section

If the malfunction shows again, contact the Service Center.

These data are necessary to help you quickly and correctly. Write the necessary data here, refer to the rating plate.

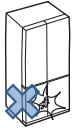
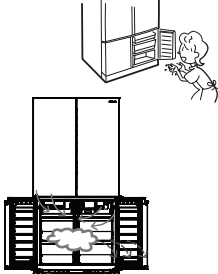

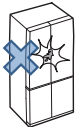
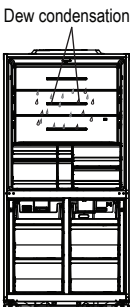
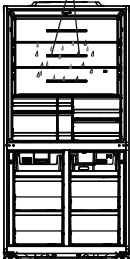
# Dew or Frost is generated

General operation	Please check here	Possible causes and / or Recommended solutions
<b>Frost or ice is generated in the freezer compartment</b>	The door of the freezer compartment was not left open temporarily?	Check that the wrapping paper of the food is not getting caught in order not to make gap between door and door gasket when you close the door. 
	The door of the freezer compartment was not opened frequently or longer time than necessary?	When the door is opened frequently or if the door is opened when the humidity around the refrigerator is high, moisture in the air may be turned into some frost or ice on the inner wall or component of the freezer compartment, or around the air channels. This is not a failure. Please try not to open the door too many times or for a long time. Also, please wipe frost or ice generated in the freezer compartment off with use of a dry cloth. 
	Making extra ice by using an additional ice-tray which was not originally installed in the refrigerator?	When the many containers in which water or liquid is stored are put in the same time, water or liquid may be evaporated and turned into frost or ice on the wall or component of the freezer compartment, or around the air channels. You can suppress these frost and ice by putting lid to avoid evaporation. Please wipe frost and ice off with use of a dry cloth. 
<b>Dew is generated in the refrigerator compartment</b>	The door of the refrigerator compartment was not left open temporarily?	Please check not to pinch the food or plastic bag between the door and door frame when you close the door. 
	The door of the refrigerator compartment was not opened frequently or longer time than necessary?	When the door is opened frequently or if the door is opened when the humidity around the refrigerator is high, moisture in the air may be turned into some dew on the inner wall or component of the refrigerator compartment, or around the chilled air blow-off port. This is not failure. Please try not to open the door too many times or for long time. Also, please wipe off the dew in the refrigerator compartment with dry cloth. 
	Storing many vegetables containing much water?	The humidity of the vegetable compartment is higher than other compartments. Accordingly, depending on the amount or type of the vegetable, dew condensation may be generated on the plastic case of vegetable compartment. However, this is not a failure. When you do not want to have this kind of dew, please wrap your vegetables in a plastic film. Also, when the dew condensation happens many times, water may be accumulated in the vegetable compartment. Please wipe the water off with a dry cloth. 
<b>Dew is generated on outer surface of the refrigerator</b>	The volume of humidity around the refrigerator is not high?	When the humidity rises such as in rainy day, some dew may be generated on the outer surface of the refrigerator. Please wipe the dew off with a dry cloth. 
	The temperature setting is not set as "Coldest"?	When the temperature setting is set as "Coldest", some dew may be generated on the outer surface of the refrigerator. Please set the setting as "Normal". Also, please wipe dew off with use of a dry cloth. 

## Why frost and dew are generated?

When warm and humid air contacts something cold, dew is generated. For example, if you put some ice in the glass in your room, air around the glass will be cold down and some dew may be generated on the outer surface of the glass.

In the same way, when warm and humid air enters into the refrigerator at the door opening, the warm and humid air contacts cold inner wall and little dew may be generated.

Accordingly, if the door opening is too frequent or too long, dew will be accumulated at every door opening. In some cases, dew may be frozen to generate some frost or ice flakes in the freezer compartment.

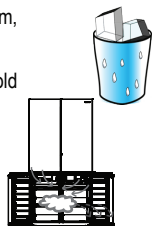

# Service Center

---

- Before you request repair, please check the refrigerator well according to page number 17. If it is still abnormal, please contact the retailer of purchase or the following service center.

Service Center	TEL No.
<ul style="list-style-type: none"><li>• Arcelik Hitachi Home Appliances Sales Malaysia Sdn.Bhd.</li><li>• Arcelik Hitachi Home Appliances Sales (Singapore) Pte. Ltd</li></ul>	<ul style="list-style-type: none"><li>• 1-800-88-1122</li><li>• 62787177</li></ul>

## About Non-fluorocarbon refrigerator

- This refrigerator, including refrigerant and the heat insulator, is using hydrocarbon (non-fluorocarbon). The hydrocarbon is a material that does not rip up the ozone and have very little influence on global warming. It is the global environment concern material).
- R600a refrigerant is flammable. But the refrigerant is sealed up by the refrigerant circuit, and never leaks by usual use. In case of the refrigerant circuit being damaged by any chance, please avoid using fire or electric product, open the window and ventilate. Afterwards, please contact Hitachi Service Center.

## Sever warning signs for Disposal

Cyclopentane is used as in the insulation. The gases in insulation material require a special disposal procedure. Please contact your local authorities in regard to the environmentally safe disposal of this product.



This symbol mark means that used electrical and electronic products shall not be mixed with general household waste. Do not try to dismantle the system and unit by yourself as this could have harmful effects on your health and the environment. Refrigerators must be treated at a specialized treatment facility for recycling and recovery and shall not be disposed of in the municipal waste stream. Please contact the installer, dealer or local authority for more information.

